

# ANIMALS EAT

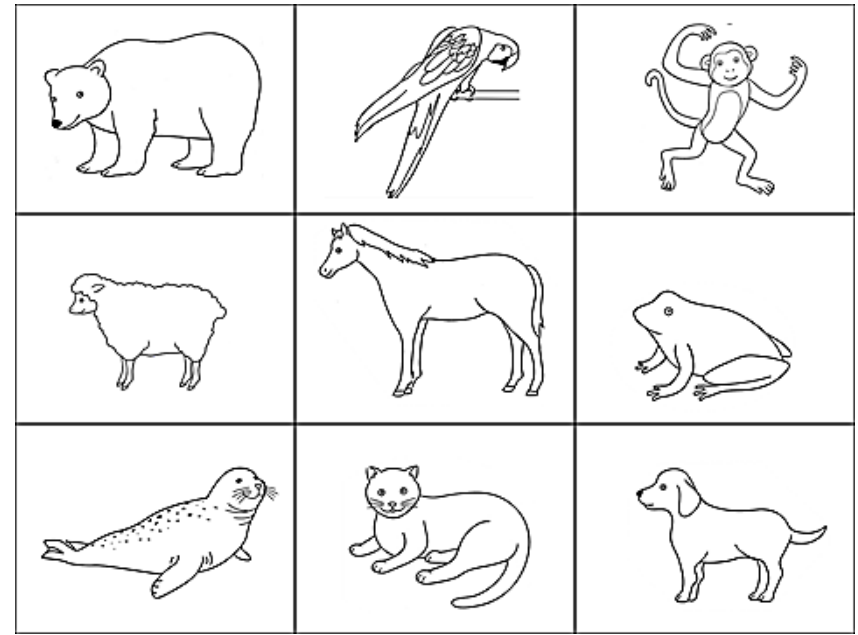

# ANIMALS & FOOD

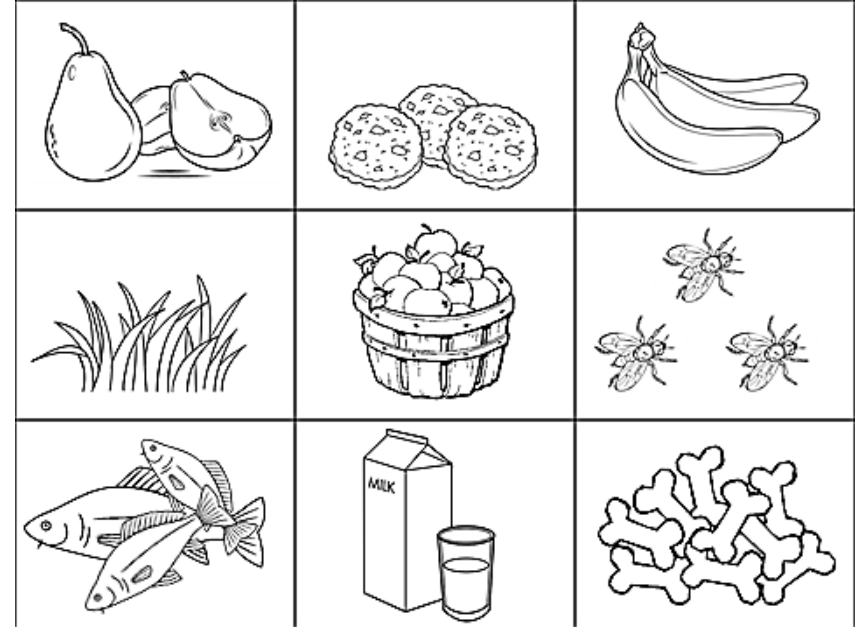

This is Bobby the bear.  
Bobby loves pears.

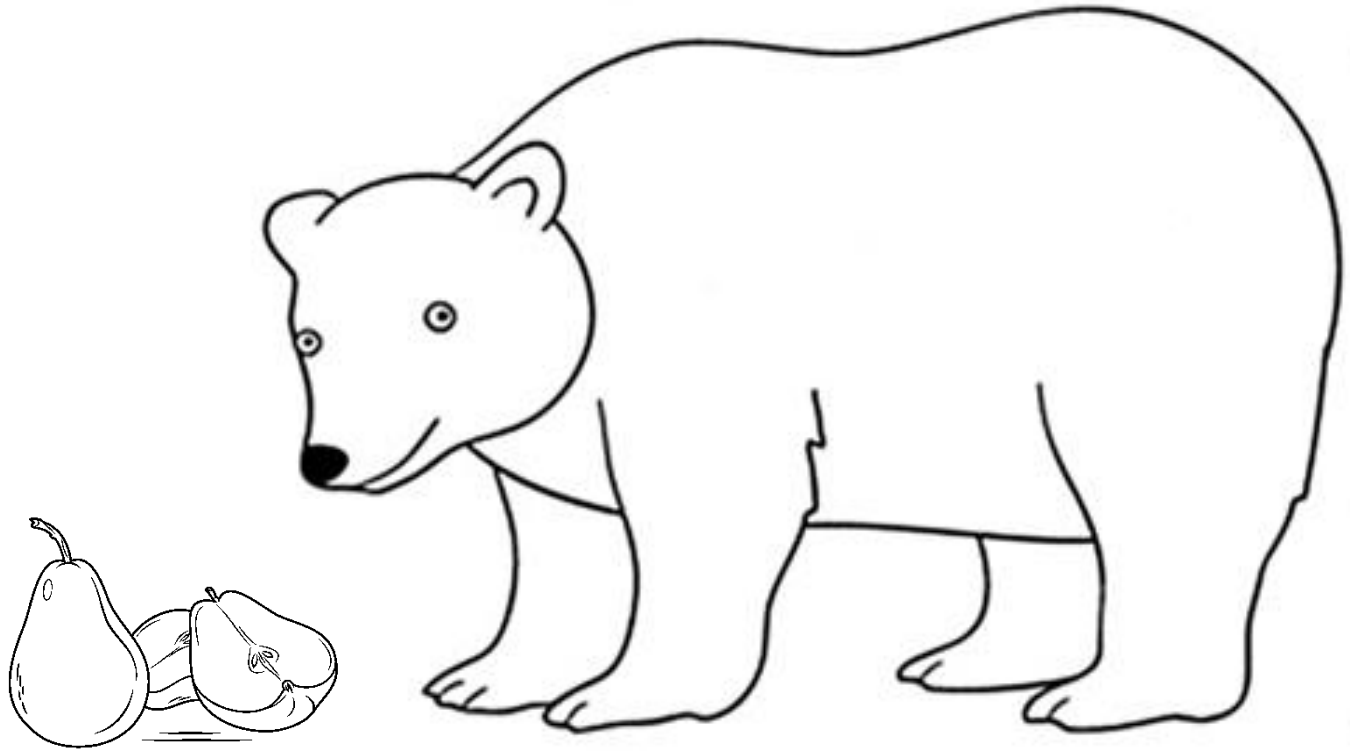

He has pears for breakfast,  
Pears for brunch,  
Pears for dinner  
And pears for lunch

This is Pinky the parrot.  
Pinky loves cookies.

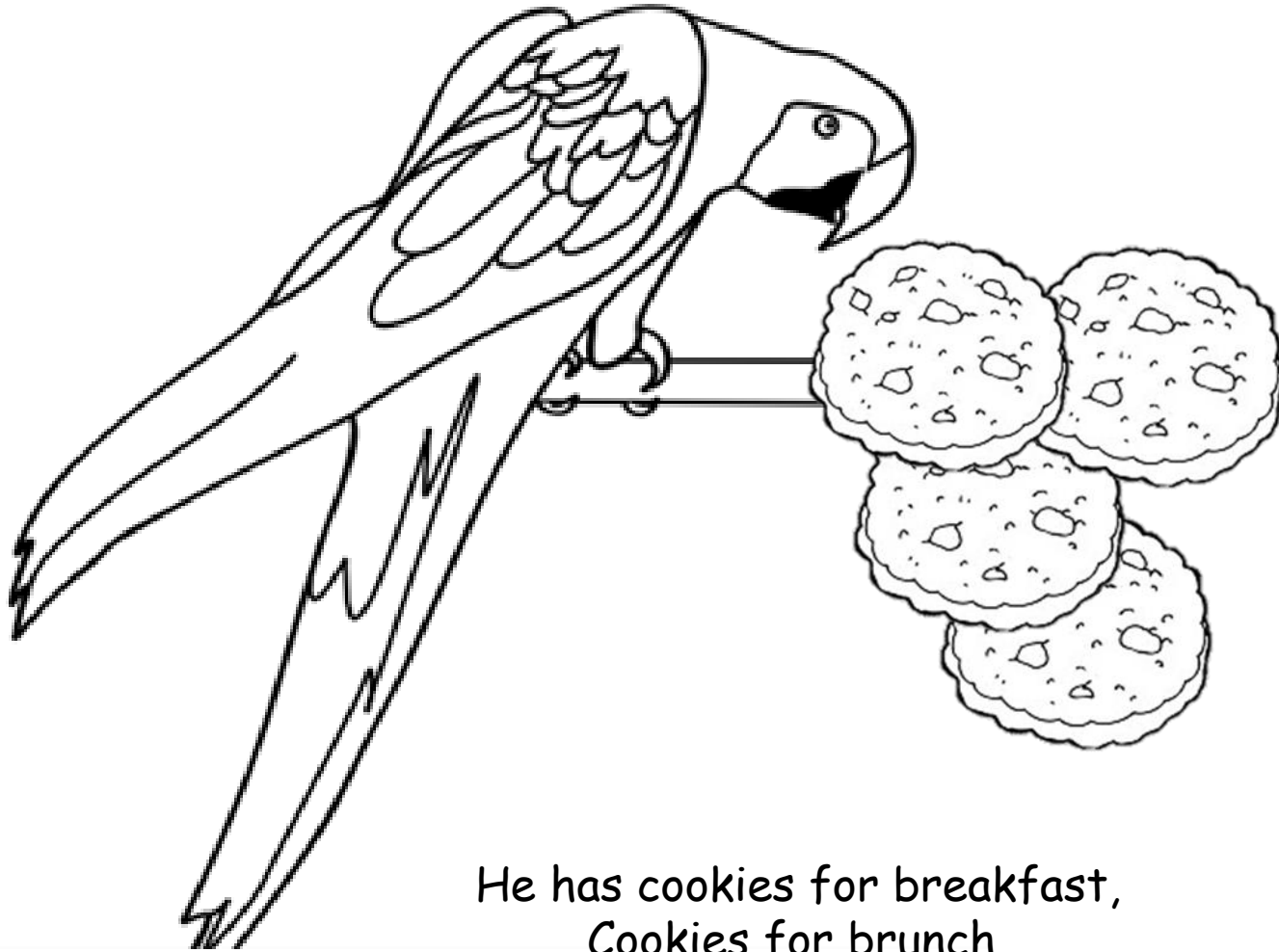

He has cookies for breakfast,  
Cookies for brunch,  
Cookies for dinner  
And cookies for lunch

This is Max the monkey.  
Max loves bananas.



He has bananas for breakfast,  
Bananas for brunch,  
Bananas for dinner  
And bananas for lunch

This is Shaun the sheep.  
Shaun loves grass.

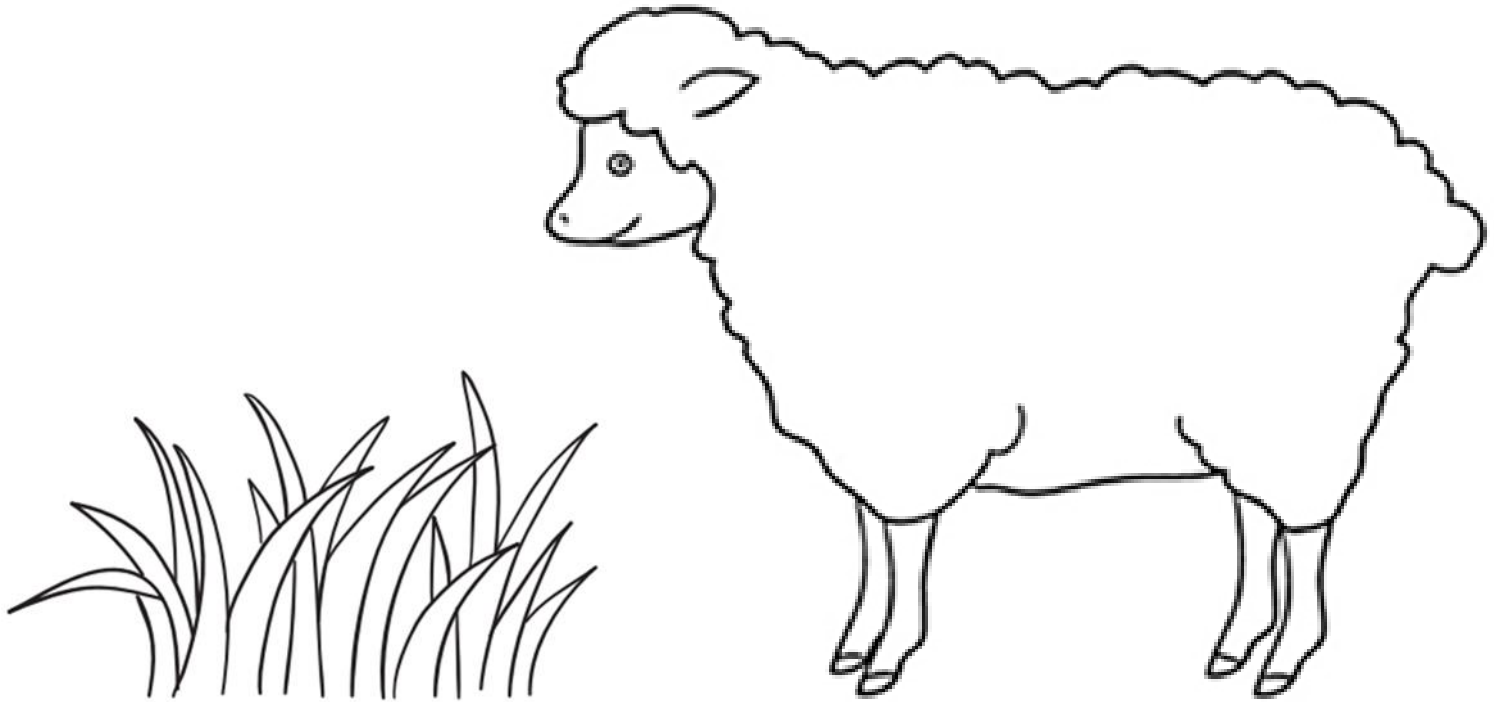

He has grass for breakfast,  
Grass for brunch,  
Grass for dinner  
And grass for lunch

This is Hector the horse.  
Hector loves apples.

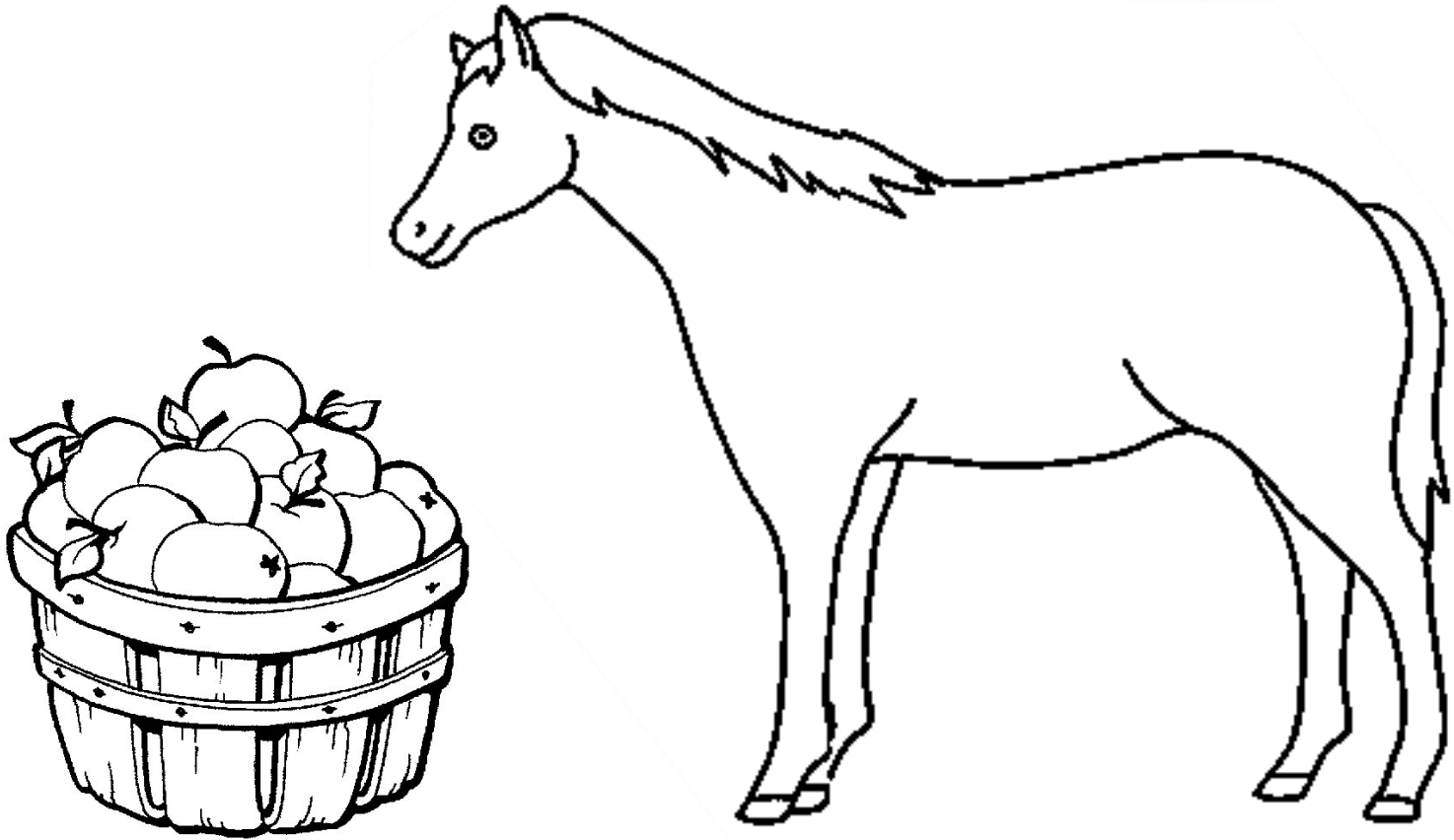

He has apples for breakfast,  
Apples for brunch,  
Apples for dinner  
And apples for lunch

This is Freddy the frog.  
Freddy loves bugs.

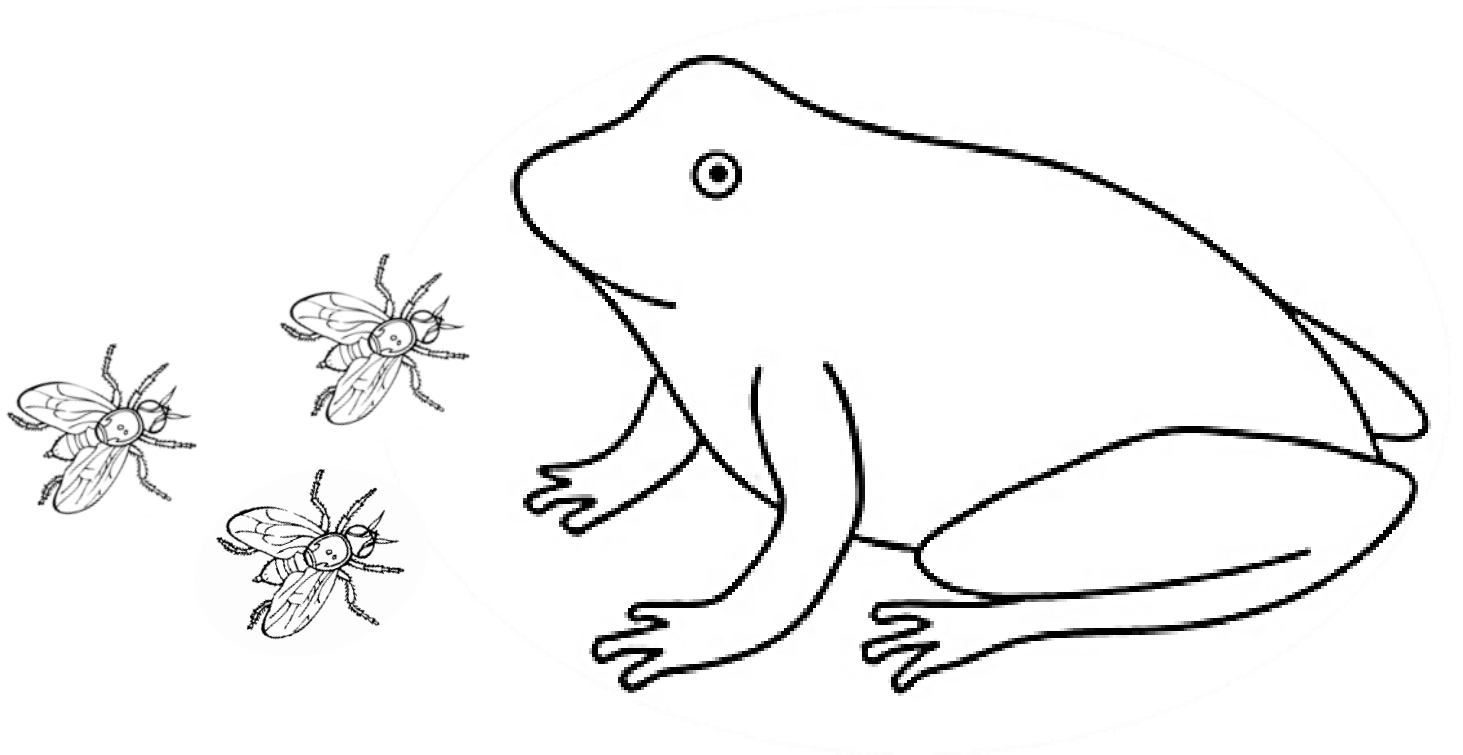

He has bugs for breakfast,  
Bugs for brunch,  
Bugs for dinner  
And bugs for lunch

This is Sandy the seal.  
Sandy loves fish.

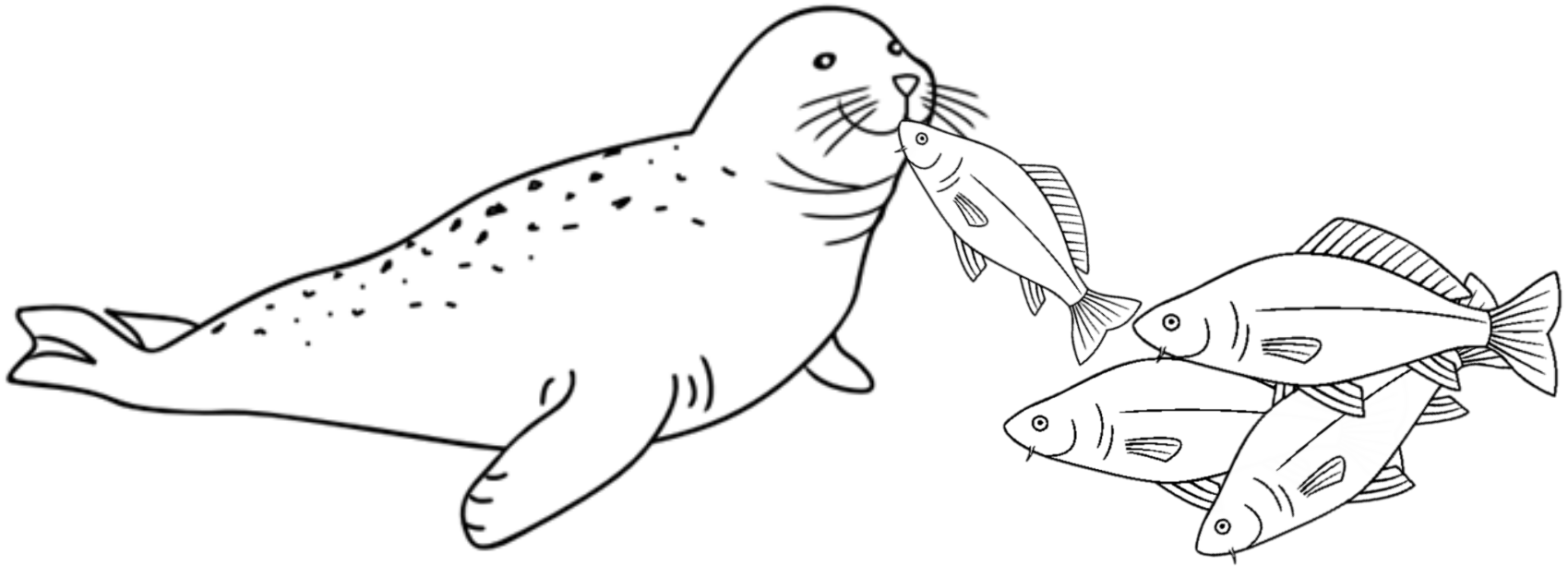

She has fish for breakfast,  
Bugs for brunch,  
Bugs for dinner  
And bugs for lunch



This is Kitty the cat.  
Kitty loves milk.

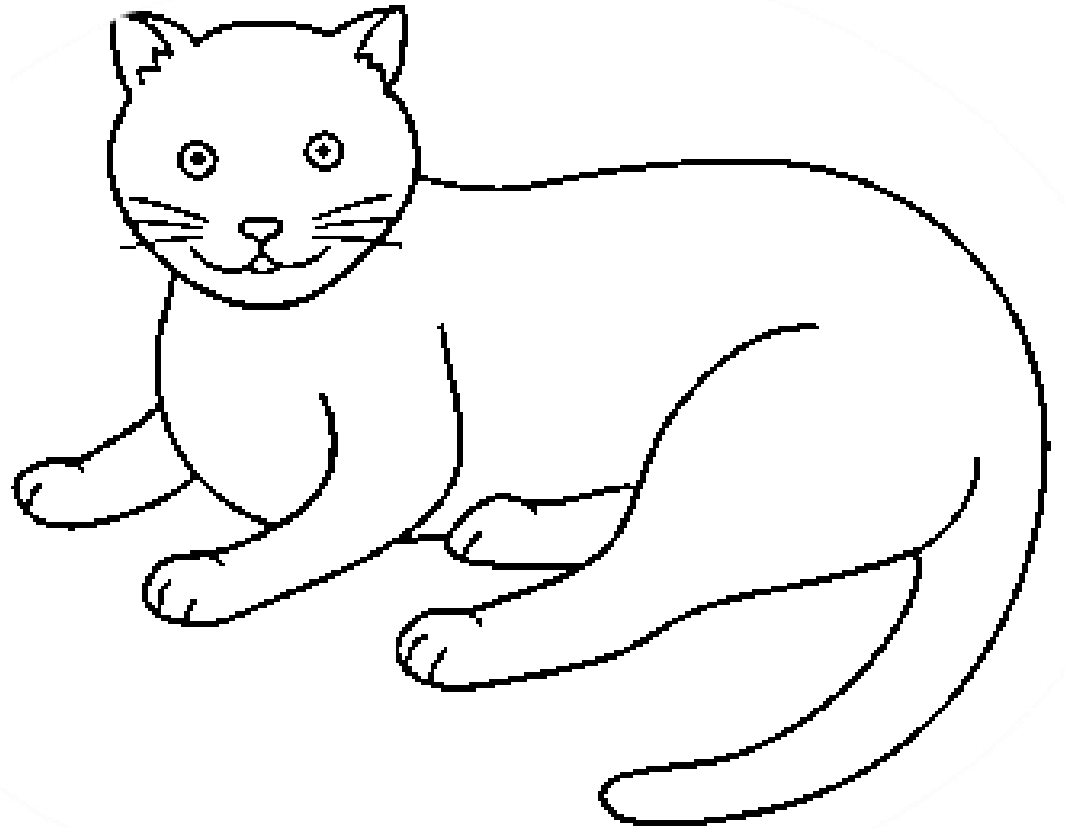
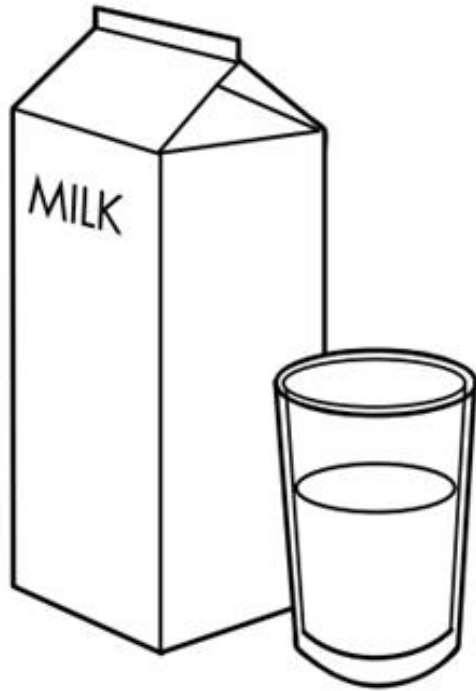

She has milk for breakfast,  
Milk for brunch,  
Milk for dinner  
And milk for lunch

This is Dingo the dog.  
Dingo loves bones.

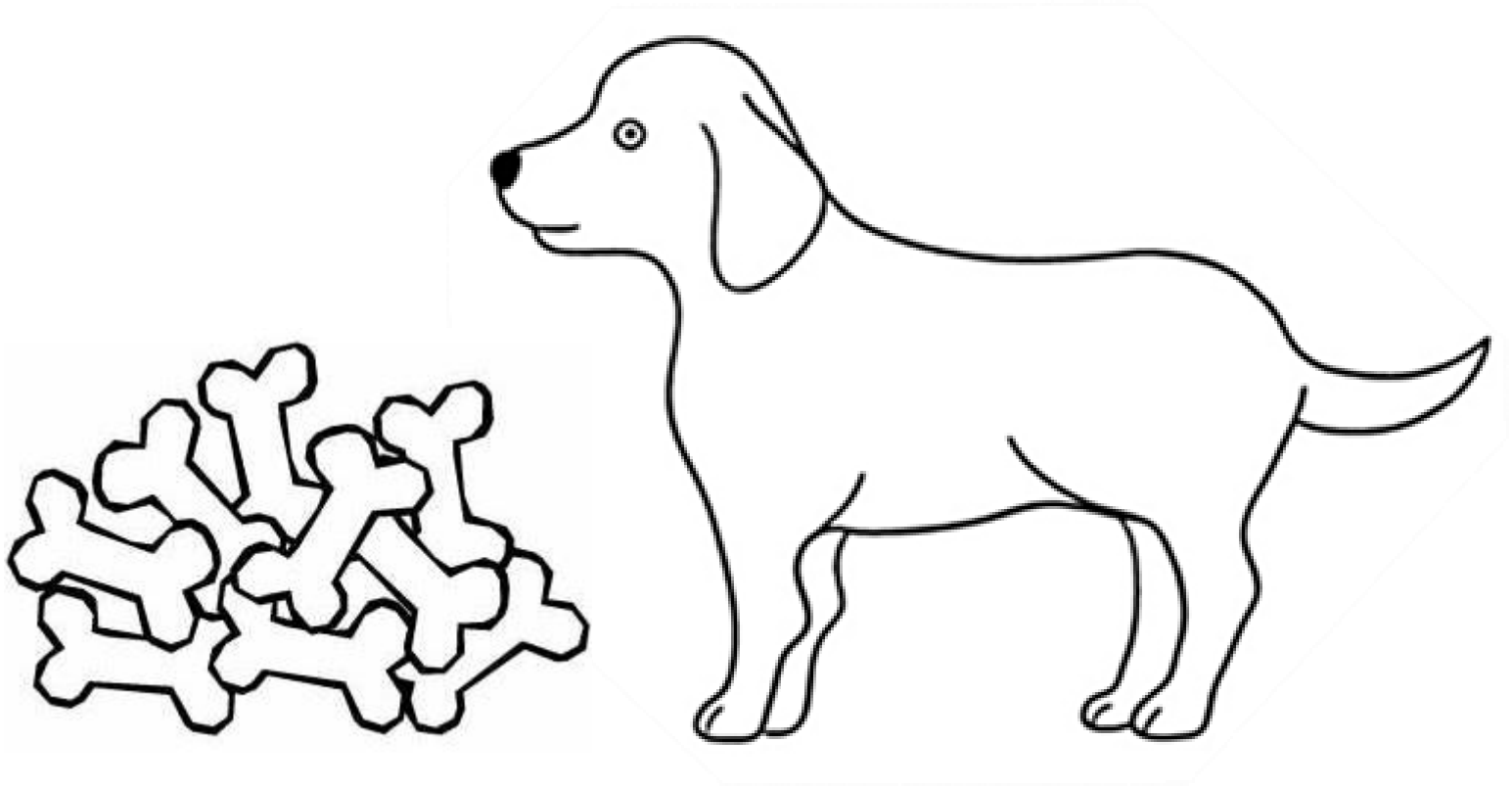

He has bones for breakfast,  
Bones for brunch,  
Bones for dinner  
And bones for lunch

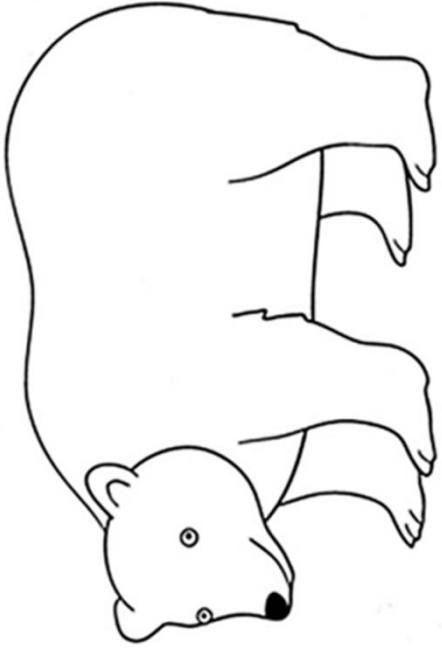

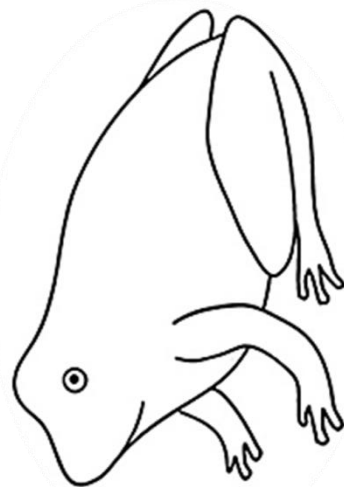
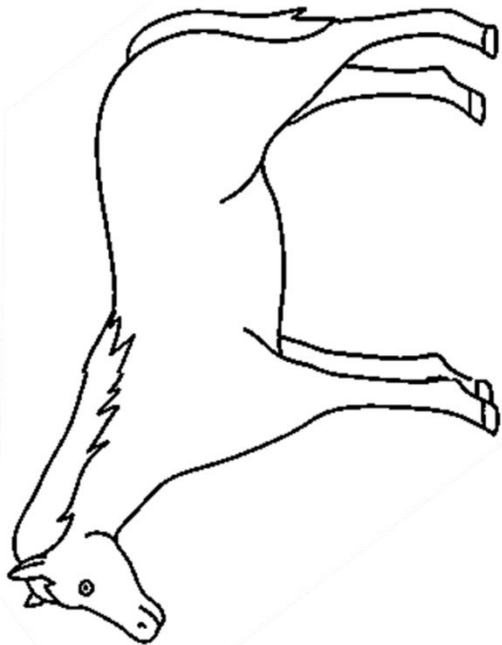

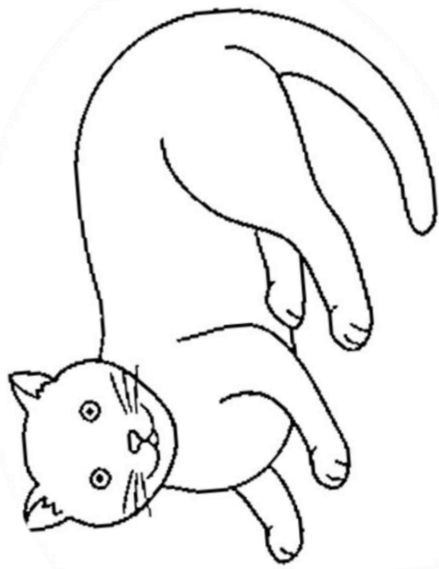
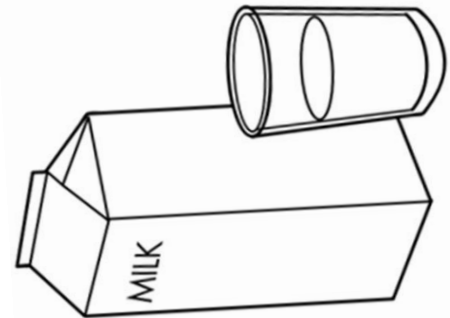
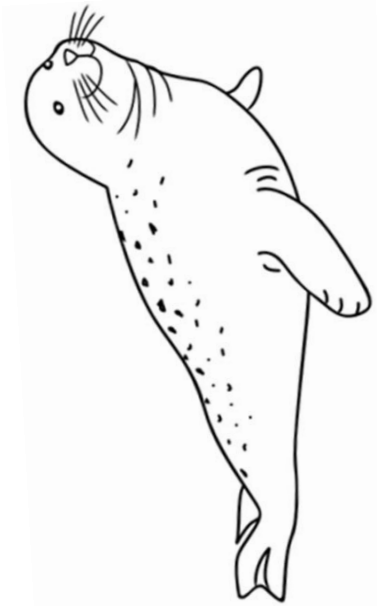

# What would you like to eat?

